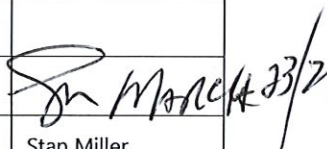

STANDARD OPERATING PROCEDURE

Press Tooling; Use Of		Document Number: 960C-SOP-506
Original Approval Date: MAR 10, 2010	Revision Number: 2	Page 1 of 13
Latest Revision Date: MAR 15, 2021	Next Revision Date: MAR 15, 2024	Document Approval Level: 4

This document is not controlled if printed.

PRESS TOOLING; USE OF

2	APP	MAR 15, 2021	Approved	Andre Brule	Tammy Siver	 Stan Miller
Rev	Status	Rev. Date	Status Description	Prepared by	Reviewed by	Approved by



STANDARD OPERATING PROCEDURE

Press Tooling; Use Of		Document Number: 960C-SOP-506
Original Approval Date: MAR 10, 2010	Revision Number: 2	Page 2 of 13
Latest Revision Date: MAR 15, 2021	Next Revision Date: MAR 15, 2024	Document Approval Level: 4

This document is not controlled if printed.

The following is a step by step procedure on how to complete a specific task or meet a facility specific requirement. Standard Operating Procedures (SOPs) are written for all identified critical tasks. By virtue of the hazard or complexity associated with critical tasks it is paramount that the SOP be followed as written. SOPs contain a listing of high-level hazards associated with the task, for detailed hazard analysis reference the applicable Task Hazard Assessments. SOPs do not replace the requirements contained in the company Standards, Codes, and Processes nor does it replace the need to comply with required legislation. Section 8.0 references documentation that the worker shall understand before work commences.

1.0 PURPOSE

- To establish a company standard to safely and effectively carry out work as it applies to using press tooling.

2.0 SCOPE AND APPLICATION

- This document applies to all company Heavy Construction & Mining operations. Ensure all site-specific requirements are being met or exceeded before performing the task.

3.0 HAZARDS AND CONTROLS

- Personnel not trained or competent to operate pressing tools/equipment.
 - Supervisors must ensure that workers involved in pressing activities are competent and understand the task prior to using the equipment.
 - The worker must be familiar with the operating functions of pressing equipment before operation.
- Equipment failure, uncontrolled movement of equipment, parts, and components.
 - Complete the appropriate maintenance inspections, checks and service, as per the manufacturer's recommendations.
 - The worker is responsible to complete visual inspections on pressing tools prior to commencing work. The worker must also report any conditions affecting the safe operation of the pressing tools to the supervisor.
 - Ensure equipment, parts and components being pressed have been isolated from movement. All parts and components being pressed must be secured to prevent unintentional movement.
 - Do not modify, alter, or remove any guards or safety device from pressing tools.
- Components of the press assembly, parts and/or material blowing apart during the pressing process resulting in personal injury and property damage.
 - Ensure the parts and the press have good alignment. All components must be rated for the pressures involved (do not use hardened steel for blocks, spacers, or rods).

STANDARD OPERATING PROCEDURE

Press Tooling; Use Of		Document Number: 960C-SOP-506
Original Approval Date: MAR 10, 2010	Revision Number: 2	Page 3 of 13
Latest Revision Date: MAR 15, 2021	Next Revision Date: MAR 15, 2024	Document Approval Level: 4

This document is not controlled if printed.

- If equipped, ensure the press cage is down or in place to prevent personal injury. Always stay behind the press cage when pressing is in progress. If there is no press cage to protect the worker a face shield and leather apron must be used.
- Manual lifting and handling heavy and/or awkward parts and components.
 - Inspect travel path prior to task; remove tools, debris, and other tripping hazards.
 - Do not lift any load greater than 50lbs without assistance from another person or a mechanical lifting aid. Follow 962C-SOP-009 Manual Lifting and Carrying Heavy Objects.
 - Assess and identify the weight of the load to be lifted. Be sure you can lift the load without overexertion.
 - Use proper body mechanics when lifting, i.e. shoulders and feet square to load, lift with your legs from squat position, and keep back straight.
- Pinching, crushing and line of fire hazards.
 - Personnel must be clear when activating the press, keep body parts out of pinch points and line of fire hazards. If equipped stand behind the press cage (see Appendix B for examples).
 - The worker operating the press is responsible to ensure all personnel are clear of pressing equipment prior to operation.
 - Place a dampening device, such as a heavy blanket, screen guard or other material over the component to reduce energy when removing stuck or seized pins (follow 960C-SOP-310 Removal of Stuck or Seized Pins on Earth Moving Equipment).
- Hydraulic fluid injection resulting in personal injury.
 - Ensure hoses are built for hydraulic fluids and rated for the pressures of the pressing tools.
 - Conduct a visual inspection. Do not use your hand when performing inspections on the hydraulic hoses and fittings. If you suspect a leak stop the equipment and notify your supervisor.
 - Do not handle the hose or fittings while the unit is pressurized or on and ready to run.
 - Any time high pressure lines are going to be disconnected, the pressure needs to be bled from the system.
 - Untreated hydraulic fluid can result in compartment syndrome, necrotic tissues, amputations, and even death. If you have come into contact with pressurized hydraulic fluid notify your supervisor right away.
- Crane and rigging failure resulting in personal injury and/or property damage.

STANDARD OPERATING PROCEDURE

Press Tooling; Use Of		Document Number: 960C-SOP-506
Original Approval Date: MAR 10, 2010	Revision Number: 2	Page 4 of 13
Latest Revision Date: MAR 15, 2021	Next Revision Date: MAR 15, 2024	Document Approval Level: 4

This document is not controlled if printed.

- Only competent workers will perform rigging activities.
- Inspect crane and rigging used to hoist pressing tools, components and parts.
- Ensure all rigging, including shackles, hooks and slings, are rated and exceed the lifting capacity required for the load to be lifted.
- Know the weights of all components/parts to be lifted.
- Ensure the swing area is clear of obstructions. No worker shall stand or pass under a suspended load. Tagline(s) will be used on all suspended loads (follow 950C-C-008 - Cranes Hoisting and Rigging Code).

4.0 CHECKLIST

- Attend all preparatory meetings (IE: daily PSI; job scope; review of JSA's and SOP's for the job)
- Complete FLRA cards before starting the work.
- Ensure all personnel involved in the task are aware of the hazards and the controls to be used, as identified in the SOP's; JSA's; and FLRA's
- Conduct a pre-job inspection of all equipment to be worked on and tools to be used.
- Standard of Training required for working on this job: On-the job training.**

5.0 DEFINITIONS

5.1 Company

- North American Construction Group (NACG) and all directly or indirectly owned subsidiary companies, including joint ventures.

5.2 Company Personnel

- Includes the Company's employees, officers, directors, agents, associates, consultants/contractors, temporary employees and third-party processors.

5.3 Guard

- Physical barrier designed to limit or prevent access to a hazardous area.

5.4 HSE

- Refers to the Health, Safety & Environment department

6.0 PROCEDURE

6.1 General Safety Procedure

1. Supervisor and workers will discuss the task and plan the safest way to approach the work. Workers will complete an FLRA card to identify hazards and controls.
2. To avoid personal injury or death, carefully read and understand all instructions before attempting to operate any pressing equipment and/or tools.

STANDARD OPERATING PROCEDURE

Press Tooling; Use Of		Document Number: 960C-SOP-506
Original Approval Date: MAR 10, 2010	Revision Number: 2	Page 5 of 13
Latest Revision Date: MAR 15, 2021	Next Revision Date: MAR 15, 2024	Document Approval Level: 4

This document is not controlled if printed.

3. Complete a visual inspection on all pressing equipment, parts and components prior to use.

6.2 Stationary Vertical Press

1. Check the specifications of the work and the press to ensure they will work together.
2. Set up the press: proper space from the press head to the part; the base will be stable and of cold steel and able to withstand the pressure; the tooling is of the proper material (shafts, spacers, blocking, etc.), size, and weight.
3. Arrange the part with good support and alignment. Minimize the stroke and spacers from the press to the part. Move the bed up closer to the work, or build up the blocking below.
4. Place appropriate material to catch the piece as it falls out to avoid damage.
5. Align the part with the press shaft and apply enough tension to hold them together.
6. Close and latch all the guards around the press.
7. When activating the press, keep body parts out of pinch points and line of fire hazards. If equipped stand behind the press cage. The worker operating the press is also responsible to ensure all personnel are clear of pressing equipment prior to operation.
8. Always relieve the pressure before approaching the press to check or adjust.
9. Restore the press, area, and tooling to the proper positions and storage spots.
10. Do not operate the press if you find damage or faults. Tag out the press and write on the tag the damage.
11. Report any damage or faults immediately.

6.3 Portable Press used Horizontally or Vertically

NOTE: Portable pressing is utilized in numerous situations this includes but not limited to pressing of articulation bearings and bushings on a motor grader, hydraulic cylinder pins, bushings and bearings, haul truck box pivot pins and bushings. It is imperative that the correct collars, dies, adapters, pulling rods be used as stated by the OEM.

NOTE: Fabricated plates, collars, dies, cannot be used unless engineer certified.

1. Follow the steps for the stationary press.
2. It is always best to have two people on the task. The person with the press controls must confirm that the other person has their body parts and tools clear of the pinch/crush points before activating.
3. If threaded rods are used they must be of sufficient size that they will hold the force (Tensile Load) being applied, Tensile strength is the maximum load in tension (stretching) that a part can carry without breaking).

STANDARD OPERATING PROCEDURE

Press Tooling; Use Of

Document Number: 960C-SOP-506

Original Approval Date: MAR 10, 2010

Revision Number: 2

Page 6 of 13

Latest Revision Date: MAR 15, 2021

Next Revision Date: MAR 15, 2024

Document Approval Level: 4

This document is not controlled if printed.

Threaded rod cannot be used if it is not equal to or greater than the maximum force being applied by the hydraulic pressing cylinder.

4. When in a horizontal position, have support for the press and spacers so a person does not take the weight of these components should they drop down when the pressure is released.
5. Take up the slack in the stroke by turning the backing nut(s) on the rod rather than using pressure. This will minimize the chances for pinches or crushes when aligning the components.
6. Where practical, place shields to stop or deflect flying material.
7. When activating the press, keep body parts out of pinch points and line of fire hazards. If equipped stand behind the press cage. The worker operating the press is also responsible to ensure all personnel are clear of pressing equipment prior to operation.
8. Power up the press.
9. Always relieve the pressure before approaching the press to check or adjust.
10. Restore the press, area, and tooling to the proper positions.
11. Do not operate the press if you find damage or faults. Tag out the press and write on the tag the damage or faults.
12. Report any damage or faults immediately.

6.4 Track Press

NOTE: A track press has a "C" frame in order to get the press shaft and back plate over and inside the tracks.

1. Lift the press into place with an approved overhead lifting device. It is too heavy and awkward for manual lifting.
2. Ensure the alignment is to the correct points. If the back plate is not in alignment with the press head, the pressure may bend the frame. If the pressure continues, there may be a catastrophic failure with debris flying. The back plate must be positioned so surrounding components are not damaged by the crushing force of the press.
3. As the unit is tensioned, ensure the back plate has not slipped.
4. Follow the steps for the portable press.

6.5 Procedure to Remove Wheel Bearings

NOTE: Follow Caterpillar (NEHS1000) Tool Operating Manual - Procedure to Remove Wheel Bearings from Off-Highway Trucks.

STANDARD OPERATING PROCEDURE

Press Tooling; Use Of

Document Number: 960C-SOP-506

Original Approval Date: MAR 10, 2010

Revision Number: 2

Page 7 of 13

Latest Revision Date: MAR 15, 2021

Next Revision Date: MAR 15, 2024

Document Approval Level: 4

This document is not controlled if printed.

NOTE: To avoid personal injury always use care when handling heavy components. Overhead lifting devices, with adequate capacity must be used for assembly and operation of the tooling.

1. Refer to the tool usage charts and nomenclature charts to determine the specific components for the applicable wheel assembly.
2. Use the tool usage chart to choose the proper tool group and tooling for the specific wheel and bearing. If crossbar spacers are required, use recorded dimension (C) (wheel diameter) from the Measurements section to position crossbar spacer assemblies (2) on crossbar (1). The contact area must be positioned over the top face of the wheel assembly when the tooling is set in place. Make sure the spacing is equal on both sides of the crossbar centerline.

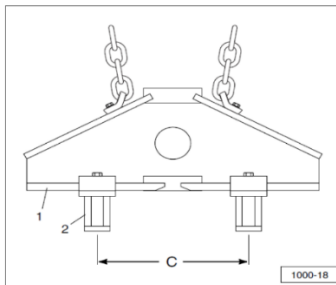

3. Securely tighten spacer clamp bolts (3) to lock the crossbar spacers in position.

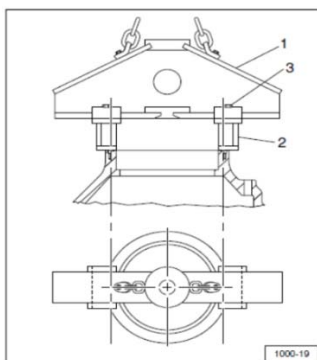

NOTE: When using the tooling on front wheel bearings, the inside edge of crossbar spacer (2) must be positioned slightly outboard of the wheel's inner diameter to allow clearance for bearing removal. Clamp bolts (3) must be used to lock spacers on crossbar (1), outboard of inner wheel lip, as shown.

4. Attach the crossbar to an overhead lifting device using rigging. Make sure the rigging will not interfere with the installation of the hydraulic cylinder.
5. Position the hydraulic cylinder on top of the crossbar and install the puller stud and upper fast runner nut. Install the lower nut to secure the hub assembly on the puller stud.
6. Using the Tool Usage Chart, determine which holes in the hub assembly and slide bars will be used to properly locate the slide bars for bearing cup removal. Each hub assembly is marked with up to three letter

STANDARD OPERATING PROCEDURE

Press Tooling; Use Of

Document Number: 960C-SOP-506

Original Approval Date: MAR 10, 2010

Revision Number: 2

Page 8 of 13

Latest Revision Date: MAR 15, 2021

Next Revision Date: MAR 15, 2024

Document Approval Level: 4

This document is not controlled if printed.

locations (A, B, or C). Each slide bar is also marked with up to four number locations (1, 2, 3, or 4). Do not set the final locations of the slide bars until the tooling is placed into the wheel hub.

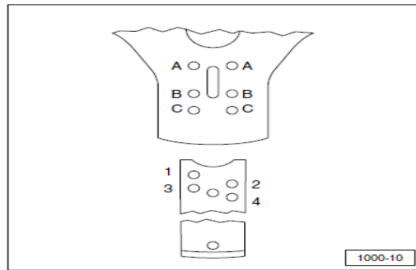

7. Insert three slide bars into the hub assembly. Install T-pin through the slot in hub assembly and the center hole in the slide bar. Push the slide bars toward the center of the hub assembly as far as possible.
8. Adjust the height of the hub assembly to the previously recorded dimension (B). Allow an additional 12 mm (0.5 in) for clearance when installing the tooling into the wheel assembly.
9. Use the overhead lifting device to lift the complete bearing removal group using the attached link brackets and lower the hub/slide bar assembly into the top of the wheel. Do not remove the rigging from the crossbar. Allow the rigging to hang loosely, with the full weight of the crossbar assembly on the wheel assembly.
10. Center the crossbar/hub assembly on the wheel assembly. Lift the tooling and reposition the crossbar if necessary. If the crossbar spacer assemblies are being used, make sure the bottom surface fully contacts the wheel flange.
11. Insert T-pins (1) in the outer, center hole of slide bars (2). Use the T-pins to push the slide bars out until they are in position under the bearing cup face (3).

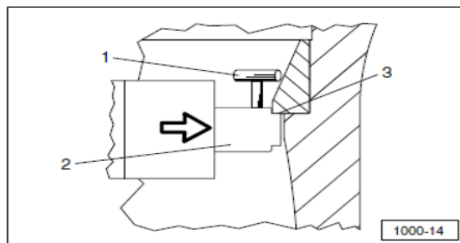

(1) T-pin. (2) Slide Bar. (3) Bearing Cup.

12. Refer to the Tool Usage chart. Insert the T-pins in the specified hub hole (marked A, B, C) which aligns with the correct slide bar hole (marked 1, 2, 3, or 4). The example shows the pin location "C2".

STANDARD OPERATING PROCEDURE

Press Tooling; Use Of

Document Number: 960C-SOP-506

Original Approval Date: MAR 10, 2010

Revision Number: 2

Page 9 of 13

Latest Revision Date: MAR 15, 2021

Next Revision Date: MAR 15, 2024

Document Approval Level: 4

This document is not controlled if printed.

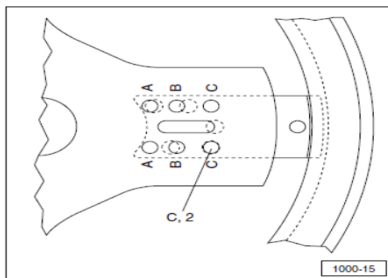

6.5.1 Bearing Cup Removal

1. Adjust the nut on top of the cylinder to raise the hub until the three slide bars engage the bottom of the bearing cup.
2. Connect the hydraulic power supply hoses to the hydraulic cylinder quick disconnect fittings.
3. Connect the hydraulic pump power supply cord to a grounded 115VAC, 50-60 Hz power supply.
4. Refer to the Tool Usage chart and adjust the pressure at the hydraulic pump to limit the maximum cylinder force as shown in the chart.
5. Use the hydraulic pump control lever to actuate the cylinder and remove the bearing cup. (Note: The breakout force necessary for removing the bearing cup may briefly exceed the maximum force listed in the Tool Usage chart, but should never exceed 1.5 times the maximum force listing.)
6. Once the bearing cup breaks loose, stop the hydraulic pump and make sure the three slide bars are still fully engaged under the bearing cup. Reposition the slide bars as needed.
7. Start the hydraulic pump and use the control lever to completely remove the bearing cup from the wheel assembly.
8. Use the overhead lifting device to carefully remove the tooling and bearing cup from the wheel assembly.
9. With the bearing cup supported, insert T-pins in center slots, and push slide bars inward to release the bearing cup from the tooling.
10. Reposition the wheel assembly with the other bearing cup facing up and repeat the bearing cup removal procedure.

6.5.2 Cleaning, Inspection & Storage

1. After use, disassemble the bearing removal group components. Clean and inspect components for damaged or worn parts.
2. Lightly lubricate the threads of puller stud(s). Each hub assembly should be cleaned and lubricated for easy movement of the slide bars.
3. Inspect slide bar contact area for wear or damage.

STANDARD OPERATING PROCEDURE

Press Tooling; Use Of

Document Number: 960C-SOP-506

Original Approval Date: MAR 10, 2010

Revision Number: 2

Page 10 of 13

Latest Revision Date: MAR 15, 2021

Next Revision Date: MAR 15, 2024

Document Approval Level: 4

This document is not controlled if printed.

4. Store the bearing removal tool groups in a clean dry location. Protect from rust and/or corrosion. Store the puller studs so that threads are protected from damage. Store other required tooling in a clean dry location. Coil up hydraulic hoses to avoid kinks and protect from damage.

6.6 D10/11 Hub Puller Tool

1. Lift track final wheel press from the stand to wheel using overhead lifting device. Install into the secondary carrier mounting surface using 1 ½" socket. Ensure all 12 press bolts are installed and tightened before use.



2. Attach the two power unit hoses to the track final wheel press. Lift wheel/spindle to hover 1" from the work area surface. Turn on the power unit. Use track final wheel press to separate wheel from the spindle.



NOTE: If the ram bottoms out before the spindle separates from the wheel, back off the press and turn off power unit and install spacer.

3. Once the wheel is separated, back off the track final wheel press and turn off the power unit. Remove power unit hoses from the press. Allow the wheel to rest on the spindle. Remove press from the wheel using the 1 ½" socket. Lift the unit to the press stand and have press and power unit removed from the work area.
4. Install two 1" eyebolts into wheel 180° apart. Attach the rigging to the lifting eyes. Lift the wheel from the spindle to the working area using the overhead lifting device.

STANDARD OPERATING PROCEDURE

Press Tooling; Use Of

Document Number: 960C-SOP-506

Original Approval Date: MAR 10, 2010

Revision Number: 2

Page 11 of 13

Latest Revision Date: MAR 15, 2021

Next Revision Date: MAR 15, 2024

Document Approval Level: 4

This document is not controlled if printed.



7.0 NOTES

If this task is to be done by a method different than described in this SOP, the work must **STOP** and the alternate method must be **DOCUMENTED** with an adequate hazard assessment tool such as a JSA. The document must be **APPROVED** by a supervisor before such procedures are implemented.

8.0 REFERENCES

- Alberta Occupational Health and Safety Act, Regulation and Code – {Part 6, Section 93 – 95 Overhead Cranes}
- Alberta Occupational Health and Safety Act, Regulation and Code – {Part 25, Tools Equipment and Machinery}
- Caterpillar (NEHS1000) Tool Operating Manual - Procedure to Remove Wheel Bearings from Off-Highway Trucks
- 950C-C-008 - Cranes Hoisting and Rigging Code
- 950C-C-013 - Equipment Guarding Code
- 950C-C-022 - General Housekeeping Code
- 950C-C-049 - PPE - General Code
- 960C-SOP-004 - Flagging Tagging and Barricading Hazardous Areas
- 960C-SOP-020 - Mechanical Lifting Aids
- 960C-SOP-403 - Crane Operation - Shop Bridge Type
- 960C-SOP-310 - Removal of Stuck or Seized Pins on Earth Moving Equipment
- 960C-SOP-504 - Hand Tools Use
- 962C-SOP-008 - Signaling Equipment
- 962C-SOP-009 - Manual Lifting and Carrying Heavy Objects

9.0 APPENDICES

- Appendix A - Types of Pressing Tools
- Appendix B - Examples of Where to Position During Pressing Operation

STANDARD OPERATING PROCEDURE

Press Tooling; Use Of

Document Number: 960C-SOP-506

Original Approval Date: MAR 10, 2010

Revision Number: 2

Page 12 of 13

Latest Revision Date: MAR 15, 2021

Next Revision Date: MAR 15, 2024

Document Approval Level: 4

This document is not controlled if printed.

Appendix A Types of Pressing Tools



Hydraulic Press



Hydraulic Press

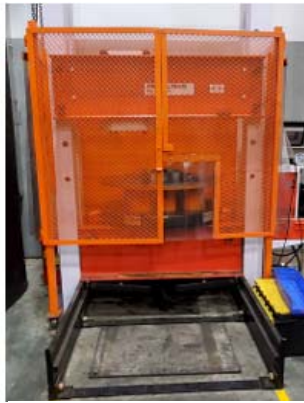

Hydraulic Press



Hydraulic Press



Hydraulic Press



Iron Worker



Bearing Puller



Hub Puller



Press Cart



Press Cart



Safety Cage

STANDARD OPERATING PROCEDURE

Press Tooling; Use Of

Document Number: 960C-SOP-506

Original Approval Date: MAR 10, 2010

Revision Number: 2

Page 13 of 13

Latest Revision Date: MAR 15, 2021

Next Revision Date: MAR 15, 2024

Document Approval Level: 4

This document is not controlled if printed.

Appendix B Examples of Where to Position During Pressing Operation

Personnel must be clear when activating the press, keep body parts out of pinch points and line of fire hazards. If equipped stand behind the press cage.

